

# TALOS™ II

Integrated

Solar

Street Light

E-LITE semicon



## THE MOST POWERFUL AND DURABLE INTEGRATED SOLAR LIGHT

Harnessing the power of the sun, the all-in-one Talos II 100w ~ 200w solar luminaire is the most powerful integrated solar light delivering zero carbon illumination to brighten your streets, pathways, and public spaces. It stands apart with its originality and solid construction, seamlessly integrating solar panels and large battery to provide real and continuous super high brightness output for long operation hours.

Embrace the future of sustainable lighting with Talos II , where style meets substance in a beautiful, efficient package.





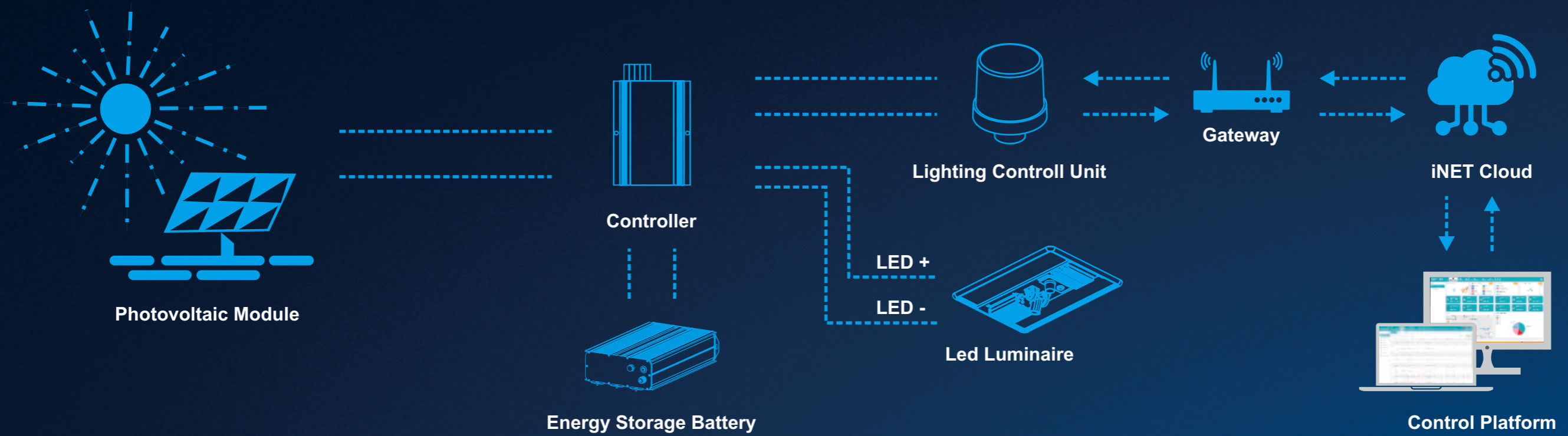

## OUR FIXTURE CAN DO



The entire lighting system is guaranteed for 5 years and the 10 years guaranteed for battery maintenance



Premium-grade Integrated All-in-one Design, Easy to Install and Maintain.



Light On/off and Dimming Programmable Smart Lighting.



Zero carbon emission



No Trenching or Cabling Work Needed.



Using Grade A+ battery cell, the battery cycle life more than 4000 times



High Luminous Efficiency of 210~213lm/W to Maximize Battery Performance.



Pivoting LED Modules Deliver the Best Lighting Control.



IP66 Luminaire Ensures Long Lasting and Consistent High Performance.

## OUR SYSTEM CAN DO



7\*24 battery life monitoring, battery life cycle reminder, work report



Built-in GPS Tracking for Product Security



Remote Real-time Monitoring and Management



Powerful Data Collection and Analysis Functions



Precise Battery Monitoring



AI Enabled Pole/Light Tilt Alarm



Flexible and Adjustable Work Mode



Seamless Integration of Charge Controllers with IoT System



## APPLICATIONS

- Street Lighting
- Roadway Lighting
- Pathway Lighting
- Ramp Lighting
- Sidewalk Lighting
- Private Road Lighting
- Farm Lighting
- Wildlife Area Lighting
- Perimeter Security Lighting
- Park Lighting
- Railway Yard Lighting
- Fence Lighting
- Campus Lighting
- Ship Dock Lighting
- Remote Area Lighting
- Military Base Lighting
- Gate Lighting
- Jogging Path Lighting



**E-LITE** semicon / [Hello@elitesemicon.com](mailto:Hello@elitesemicon.com) / [www.elitesemicon.com](http://www.elitesemicon.com)



# RELIABILITY

## UNEXPECTED VALUE



Only top quality mono - crystalline silicon solar panels with high efficiency and long lifetime are used.



Quality lithium batteries are used to store the energy, provide energy for immediate requirements, and enable a back-up for days when there is little or no sun.



High Lumen LED for maximum efficacy. Dedicated designed low-voltage solar controller technology with dimming capabilities for power-save management.  
Lifetime > 50,000 hrs and CRI nominal 70.



Microprocessor managed algorithms autonomously determine sunrise and sunset.



Easy to install without buying cables and rectifiers, directly on pole with an adjustable spigot 0°~90°.





# PHOTOMETRICS

60×100° (TYPE I -VS)

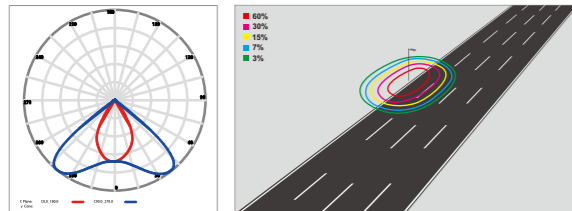

65×155° (Type II -M)

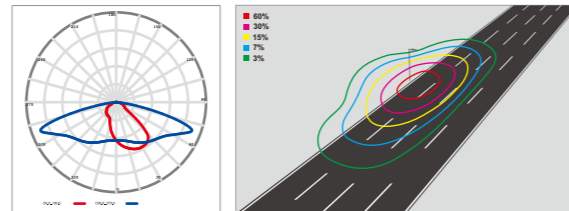

70×135° (TYPE II -S)

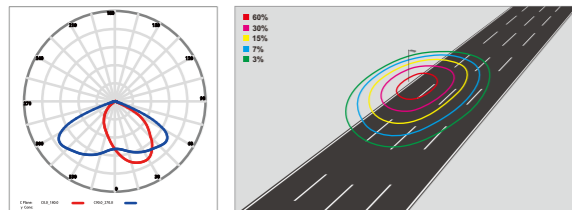

75×150° (TYPE III -M)

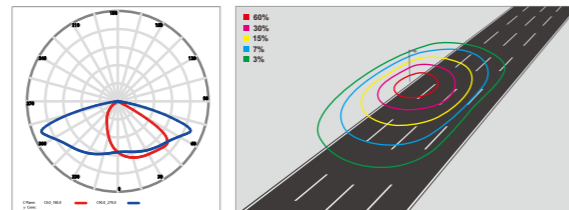

80×150° (TYPE III -S)

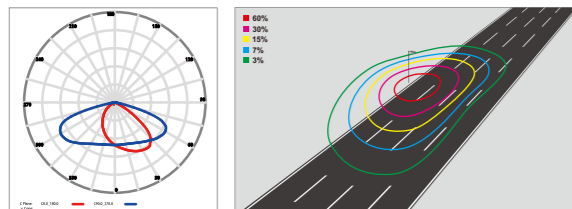

65×145° (Type IV -S)

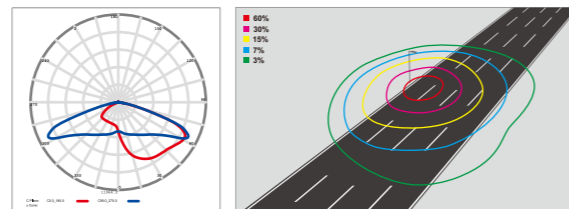

110° (TYPE V -VS)

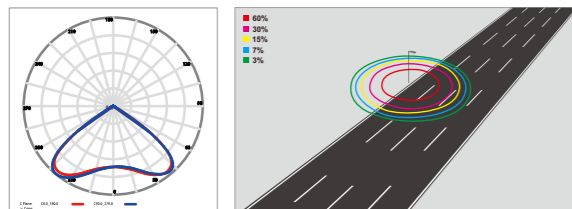

150° (TYPE V -VS)

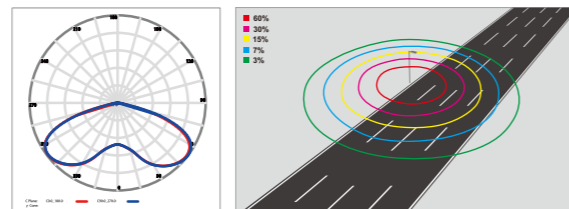

Default setting: 6m high Installation, 100% brightness.



# PERFORMANCE

	100W~200W
	210~213lm/W
	Philips Lumileds
	PIR & Microwave & Timer Dimming
	MPPT / PWM Controller
	5000K ( 2500~6500K optional )
	60×100° / 65×145° / 65×155° / 70×135° / 75×150° / 80×150° / 110° / 150°
	IP66
	IK08
	Monocrystalline silicon photovoltaic panels
	LiFeP04 battery
	Slip fitter
	Operating Temperature:-20°C to + 60°C /-4°F to 140°F (Charge:0°C to 60°C / 32°F to 140°F & Discharge:-20°C to 60°C / -4°F to 140°F) Storing Temperature:-20°C to +60°C/-4°F to 140°F



# SPECIFICATIONS

Part#	Power	Modules	LED Efficacy	Solar Panel	Battery		Product Dimensions
					Standard	Premium	
EL-TASTII-100	100W	2	210 lm/W	160W/36V	25.6V/24AH	25.6V/36AH	1150×850×220mm
EL-TASTII-120	120W	3	213 lm/W	160W/36V	25.6V/24AH	25.6V/36AH	1150×850×220mm
EL-TASTII-150	150W	3	210 lm/W	250W/36V	25.6V/30AH	25.6V/42AH	1210×1150×220mm
EL-TASTII-180	180W	4	212 lm/W	250W/36V	25.6V/36AH	25.6V/42AH	1210×1150×220mm
EL-TASTII-200	200W	4	210 lm/W	250W/36V	25.6V/42AH	25.6V/48AH	1210×1150×220mm

The solar panel and battery configuration is based on 6 hours charging time.

**E-LITE** semicon / [Hello@elitesemicon.com](mailto:Hello@elitesemicon.com) / [www.elitesemicon.com](http://www.elitesemicon.com)



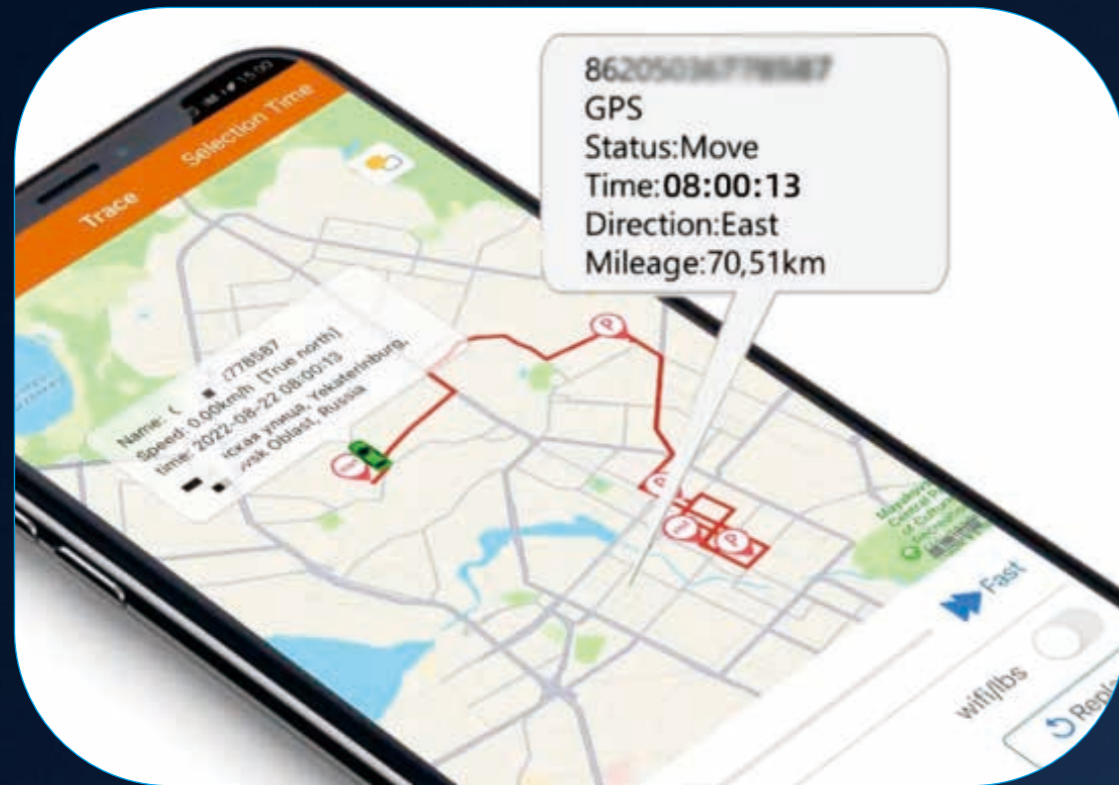

## SMART ANTI THEFT DESIGN

### Real-Time Geo Tracking

The real-time mini Geo anti theft tracking device is fitted in an un-accessible location of the solar street light fixture, which is permanently powered to enable security recovery teams to track and locate the solar lights anywhere via the live app to recover the product and arrest the thieves as long as the solar light battery has power.

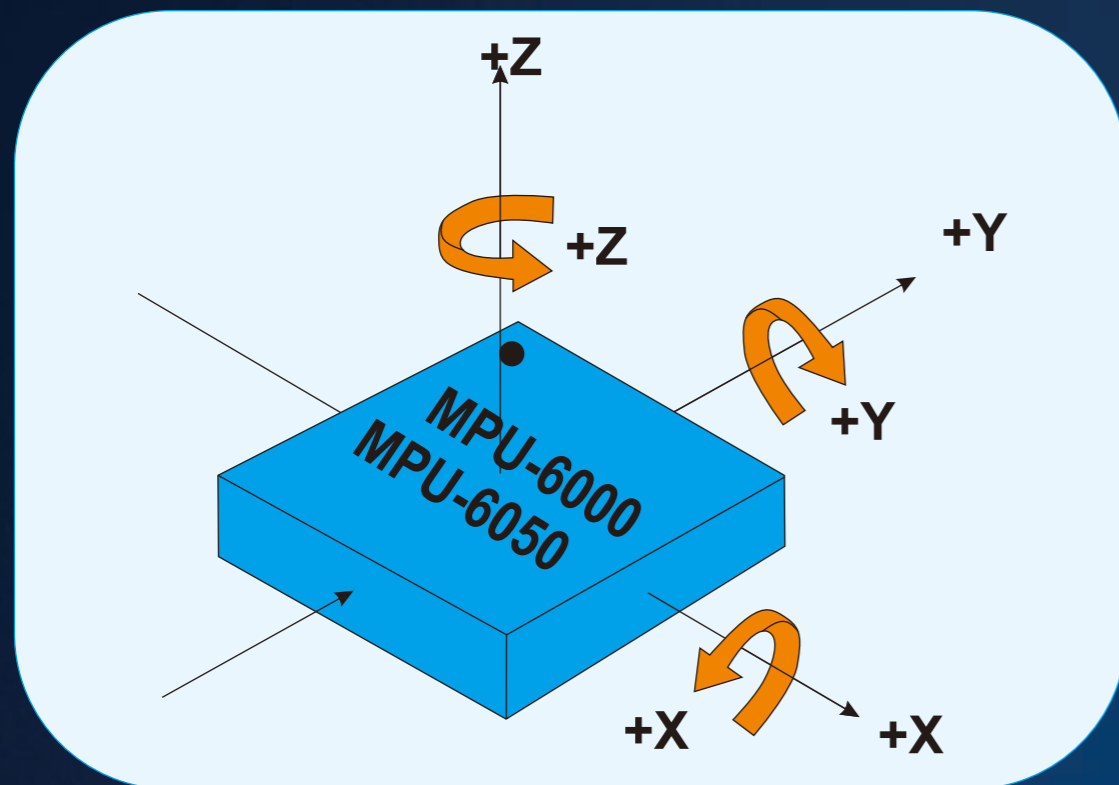

### AI Enabled Pole/Light Tilt Alarm

When the solar lights go on wireless IoT smart management system, sophisticated AI algorithm based on gyroscope and accelerometer data intelligently locks the lights' angle upon installation, any unauthorized attempt at theft or tampering will be detected, alarms will be activated at the Operation Center and alert text message will be instantly sent from Central Management Platform to the security teams.

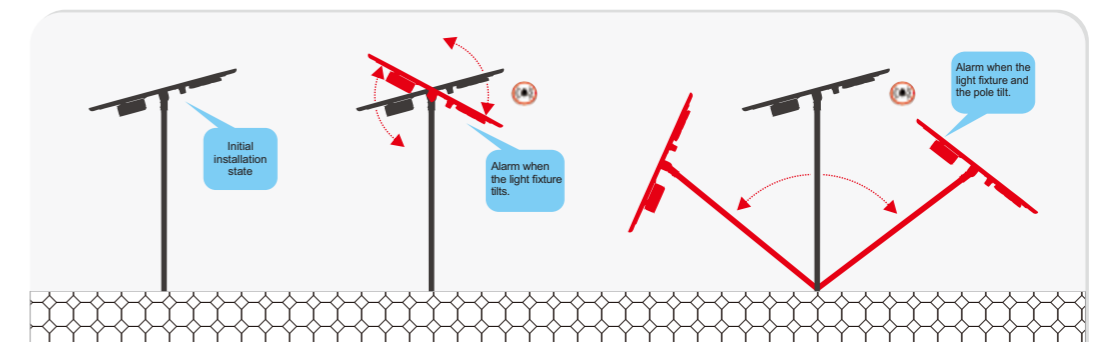



## PRECISE BATTERY STATUS MONITORING

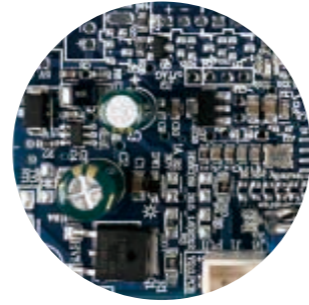

The solar light features a high-precision coulometer, also known as a coulomb meter, which provides accurate readings on battery performance by measuring its current. It can detect and display, in real-time, the battery's voltage, current, power, actual capacity, remaining time, and other key parameters, ensuring you have an accurate understanding of the battery's status at all times.

## STAY POWERFUL THE DC CHARGE PORT

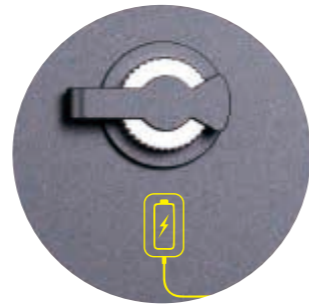

A DC charge port is offered as an option to be integrated into Talos II, ensuring the battery remains charged even during extended periods in the warehouse. No more worrying about flat batteries when you need them the most. Embrace the continuous and dependable lighting with our state-of-the-art Talos II solar street light.

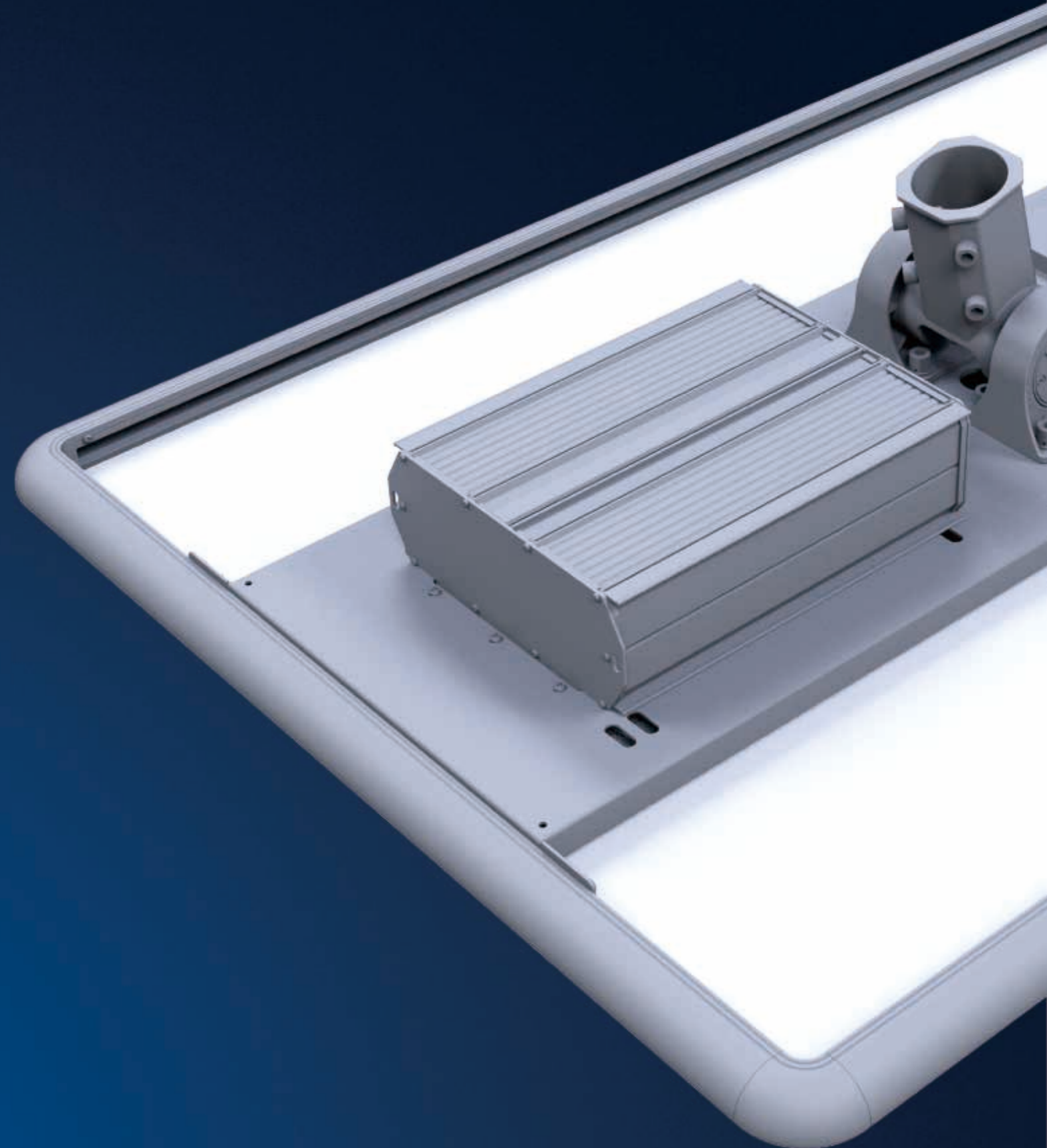



# SOLAR CONTROLLER - B

## Regular MPPT Controller



### Five-Stage Mode

The lamps lighting divide into 5 stage, each stage time and dim can be setting according to demands. With diming setting, it is an efficient way to save energy, and keep the lamp working in best power and time.

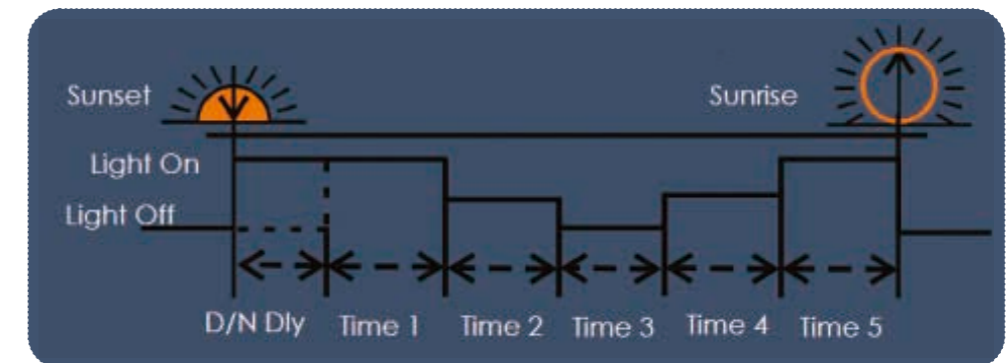

### Motion Sensor Mode

Motion: 2 hrs-100%; 3 hrs-60%; 4 hrs-30%; 3 hrs-70%;

Without Motion: 2 hrs-30%; 3 hrs-20%; 4 hrs-10%; 3 hrs-20%;

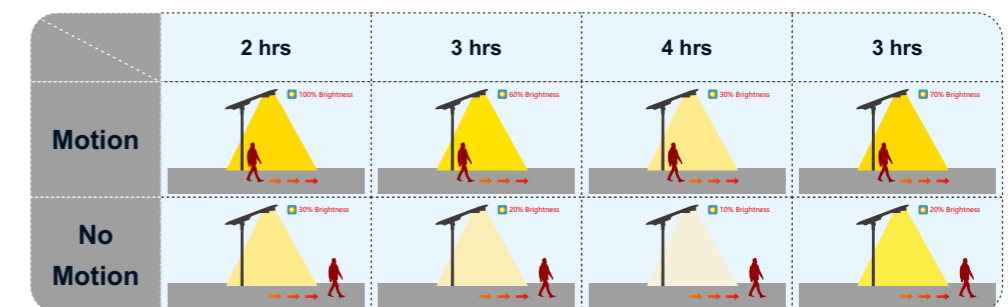



# SOLAR CONTROLLER - C

## Hybrid MPPT Controller



### Dusk to Dawn (D2D)

When fixture is set to D2D, it works in dusk to dawn mode. The fixture will turn on while the sun is down, as determined by the solar panel voltage.

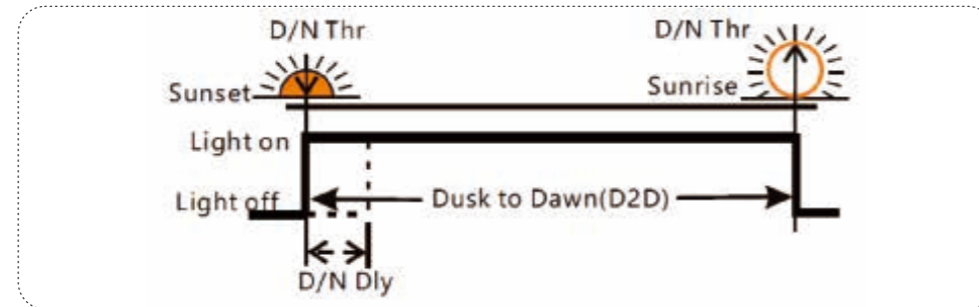

### Five-stage Night Mode

The lamps lighting divide into 5 stage, each stage time and dim can be setting according to demands. With dimming setting, it is an efficient way to save energy, and keep the lamp working in best power and time.

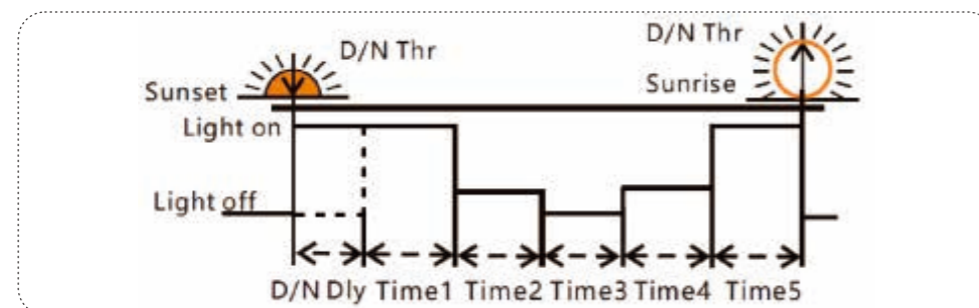

### TOT Mode (Can set the load on time before morning coming.)

When fixture is set to TOT then it will determine Time4 based on Time5 and previous data on the time of sunrise.

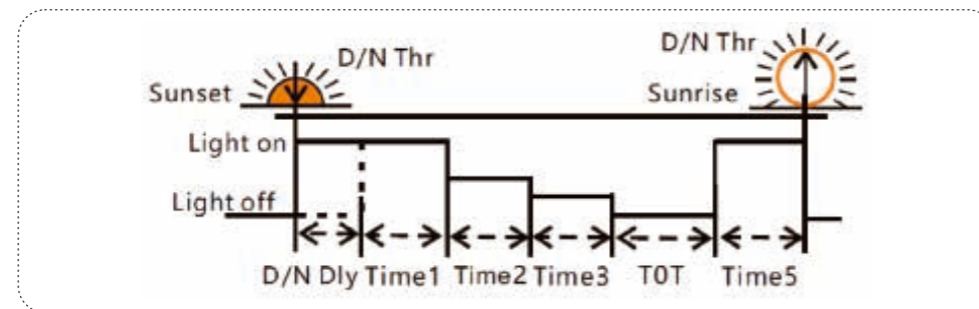

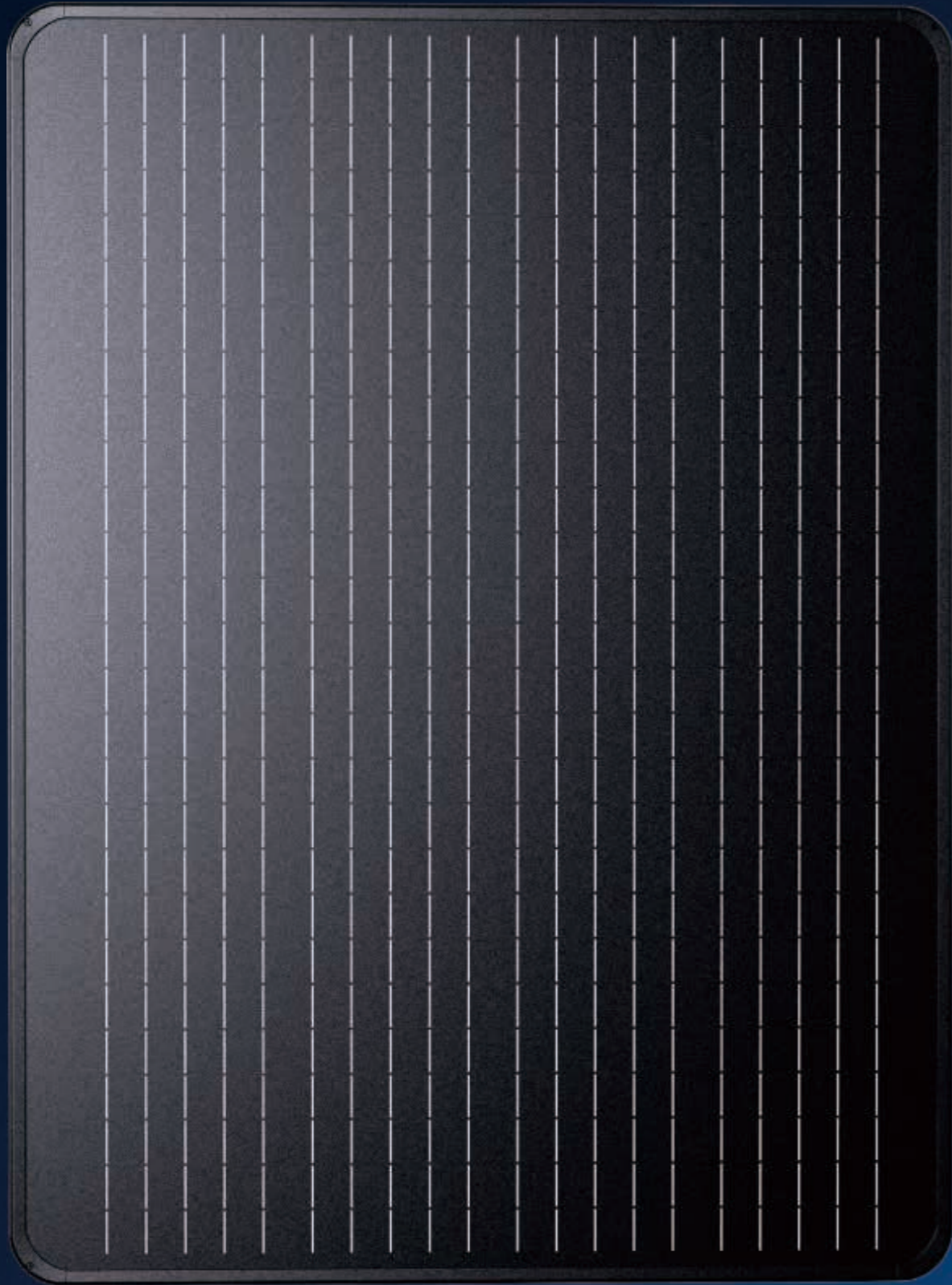

## MONO SOLAR PANEL



### Higher Durability

The multi-busbar design can decrease the risk of the cell micro-cracks and fingers broken.



### High Power Density

High conversion efficiency 23% and more power output persquare meter, by lower series resistance and improved light harvesting.



### PID Resistant

Tested in accordance to the standard IEC 62804, our PV modules have demonstrated resistancea gainst PID (Potential Induced Degradation), which translates to security for your investment.



### Bigger Cells with better performance

A slight increase of the size of our cells, Boosts the performance of the newest modules by six percent on average.



### First-class Quality Assurance

- 10-year warranty for material and technology.
- 25-year linear power output warranty.

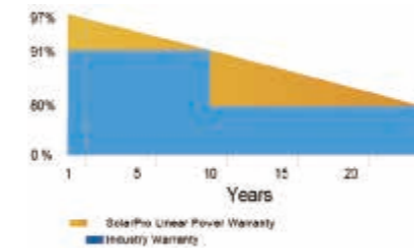

### Specifications

Maximum Power (Pmax/W)	160	250
Open Circuit Voltage(Voc/V)	43.2	
Short Circuit Current(Isc/A)	4.65	7.15
Maximun Power Voltage(Vmp/V)	36V	
Maximum Power Current(Imp/A)	4.4	6.9
Module Efficiency(%)	24	
Output Tolerance(%)	±3	
Operating Temperature	40°C~+85°C	
Wind Load/Snow Load	2400pa/5400pa	
NOCT	45±2°C	
Temp Coefficient of Isc	+0.046%/°C	
Temp Coefficient of Voc	-0.275%/°C	
Temp Coefficient of Pmax	-0.350%/°C	



# HIGH PERFORMANCE BATTERY PACK GRADE A+ CELL

LiFePO4 batteries have a higher energy density they can store more energy in a smaller and lighter package.

This makes them ideal for applications where weight and space are a concern.

## Advantage of LiFePO4

- ◆ A Long Lifespan
- ◆ No Active Maintenance
- ◆ Lightweight Champion
- ◆ High Efficiency
- ◆ Safety
- ◆ High Discharge Rates
- ◆ Extreme Temperatures
- ◆ Rechargeable Multiple Times

## Specifications

Capacity	24Ah	30Ah	36Ah	42Ah	48Ah
Nominal Voltage	25.6V				
Charging Voltage	29.2V				
Load Voltage	≥24V				
Standard charging method	5A(CC)charging to 29.2V; After CV(DC 29.2V) Charge until charging current≤0.02C				
Max charging current	≤20A				
Max discharge current	≤20A				
Over current	≤20A				
Cut off discharge Voltage	20V				
Operating temperature range	Charge: 0°C~60°C Discharge: -20°C~60°C				
Storage	-20°C~60°C				
Battery category	LiFePO4				
Cycle life	≥4000				



## LiFePO4 Battery

**2000-5000 Cycles**



**5-10 Years life**



**2.5~12.8kg**



**Environmentally friendly**

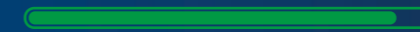

# MPPT CHARGE CONTROLLER

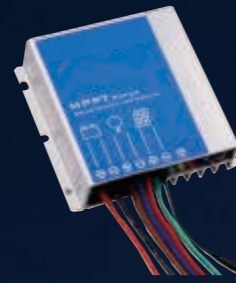

## Features

- Innovative Max Power Point Tracking(MPPT) technology,tracking efficiency >99.9%
- Full digital technology, high charge conversion efficiency up to 97.5%,discharge conversion efficiency up to 96.5%
- Can output constant current (output current can be set)
- 5 stages time and dimming can be adjusted
- Can read parameters and running status
- If battery voltage is low, it can be set to dimming
- Dimming start voltage and percentage can be set
- Day/Night threshold can adjust automatically
- AGM, Liquid, GEL and Lithium battery for selection
- 0°C Charging Protection(Lithium)
- When BMS power off because of LVD, it can activate the system automatically
- Four stages charge way: MPPT, boost, equalization, float
- IP67, Strong and durable aluminum caseFull automatic electronic protect function

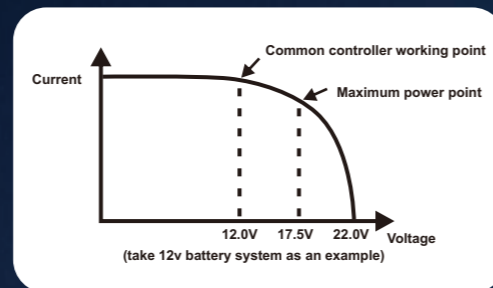

## Indicator Functions

LED	Status	Function
Green LED	On	Solar panel is correctly connected,but not charged
	Fast flash(0.1s/0.1s)	Charging
	Flash(0.5s/0.5s)	Equal or Boost Charging
	Slow flash(0.5s/2s)	Float Charging, Lithium constant voltage charge
Yellow LED	Off	Over voltage protection
	On	Battery is normal
	Slow flash(0.5s/2s)	Battery voltage is low
	Fast flash(0.1s/0.1s)	Low voltage protection
Red LED	Off	Work normal (Standard version)
	On	The output power is 0
	Super slow(0.2s/5s)	Open circuit protection
	Flash(0.5s/0.5s)	Over temperature
	Fast flash(0.1s/0.1s)	Short circuit or Over current protection

## Specifications

Battery Parameters	System Voltage	12V	12V/24V	12V/24V	12V/24V
	Max Charging Current	8A	10A	15A	20A
	Battery Type	Lithium			
	Charging Volt. Target	10.0~17.0V (Programmable, default:12.6V)	10.0~32.0V(Programmable, default: 12.6V)		
	Charging Volt. Recovery	9.2~16.8V (Programmable, default:12.4V)	9.2~31.8V(Programmable, default: 12.4V)		
	Low voltage disconnect	9.0~15.0V (Programmable, default:9.0V)	9.0~30.0V(Programmable, default: 9.0V)		
	Low voltage reconnect	9.6~16.0V (Programmable, default:9.8V)	9.6~31.0V (Programmable, default: 9.8V)		
0°C Charging protection	Yes, Slow, No(Programmable)				
Panel Parameters	Max volt on PV terminal	60V		55V	55V
	Max input power	100W~120W	130W/260W	200W/400W	260W/520W
	Dusk/Dawn detect volt.	3.0~8.0V (Programmable)	3.0~20.0V (Programmable)		
	Day/Night delay time	0~30min (Programmable)	0~30min (Programmable)		
	MPPT tracking range	(Battery Voltage +1.0V) ~Voc×0.9			
Load Parameters	Output Power	1~60W	10~60W/20~120W	10~90W/20~180W	
	Output Voltage	20 ~ 55V	15~60V/35~60V	20~55V/30~55V	
	Current setting range	0.15~3.0A (Programmable)	0.15~4.0A (Programmable)	0.15~6.0A (Programmable)	
	Min current	100mA (Dimming)			
	Current precision	±2%			
	Dimming	0~100% (Programmable)			
	Voltage of start dimming	10.0~17.0V(Lithium)	10.0~32.0V(Lithium)		
Dimming percentage	1~20% (Programmable)				
System Parameters	Max tracking efficiency	>99.9%			
	Max charge conversion	97.50%			
	Max LED driver efficiency	96%			
	Communication mode	Infrared/2.4G/RS485			
	Induction mode	Infrared Human Sensing/Microwave Sensing			
	Self consumption	6~25mA			
	Ambient temperature	-35~+60°C			
	Ambient humidity	0~100%RH			
	Protection degree	IP67			
Max Altitude	4000m				



# INSTALLATION NOTES

1. Due to variations in longitude and latitude at the installation site, the angle at which the sun's rays illuminate differs. During installation, it is crucial for the solar panel to be oriented towards the sun precisely at 12:00 noon. However, often due to factors like road direction and light poles, achieving this alignment becomes challenging. The solar panel must still maintain a horizontal position even if it can't be ideally oriented towards the sun at noon due to road lighting requirements.

Several conditions can lead to suboptimal functioning of standard lamps. Prior to making a purchase, it's important to communicate these factors to the salesperson and consider increasing the solar panel's power capacity:

- a. Any deviation below the horizontal plane of the solar panel, relative to the solar irradiation angle, will result in a significant decline in the solar panel's power generation efficiency.
- b. When installing solar lamps and lanterns, it's essential to avoid any obstacles that might block sunlight, such as trees or buildings.
- c. Natural elements like rain, ice, snow, dust, clouds, and bird droppings can reduce the solar panel's power generation efficiency.

Ensuring that the solar panel remains unobstructed by barriers like trees and buildings, and accounting for factors such as the solar panel's angle and external elements, are vital for optimal performance.

2. Install lamps at a considerable distance from areas prone to strong electromagnetic interference, such as high-voltage cables and high-power wireless transmission towers. These sources could potentially disrupt the lamp control system, leading to malfunctions and improper operation.

3. When the temperature drops below 0°C, the efficiency of lithium iron phosphate batteries for charge and discharge decreases. To prevent damage and the battery protection triggered by over-discharge, it's advisable to explain this to the sales

staff and consider increasing battery capacity before making a purchase.

4. Any environmental impact can result in a decline in the efficiency of solar panel power generation. Repeated discharge of the lithium iron phosphate battery might easily activate the protection mechanism, causing the lamps to stop functioning normally. Most lithium batteries can be restored to operation by disconnecting and reconnecting the battery-light source connection and the solar panel connection.

5. Once the battery protection has been deactivated and reactivated, our focus should be on identifying and resolving any natural environmental factors that compromise the efficiency of solar panel power generation, as well as minimizing the power consumption of the light source.

6. Install the lamps on days abundant with sunshine. The lamps are initially set to 30% power upon leaving the factory. Prior to installation and usage, ensure that the lamps can receive effective sunlight charging for at least 4 hours after activation. Failure to do so may trigger battery startup stress protection due to excessive discharge, leading to abnormal lamp operation.

7. The self-discharge and stress protection features of the lithium iron phosphate battery necessitate that if the lamp remains unused and uninstalled for a period of 60 to 90 days from the factory departure, it must undergo a 4-hour effective sun charging upon activation.

Instances where lamp functionality is compromised due to the aforementioned circumstances are not included in the warranty coverage. However, we are committed to assisting customers in identifying and analyzing the underlying causes, and devising plans for enhancements. It's important to note that lamps unable to activate after battery protection will not be covered by the warranty.



# iNET SMART CONTROL SYSTEM



## Smart City

Smart controlling perfectly combines the solar street lighting fixture, internet of things with wireless communication technology, achieve monitoring and management of remote background data, real-time understand the normal working status of each component of solar energy (street lights, photovoltaic panels, batteries, controllers), allow you to know the product usage on the client terminal that is thousands of miles away without leaving home or to manage the opening and closing of street lights and the adjustment of bright.



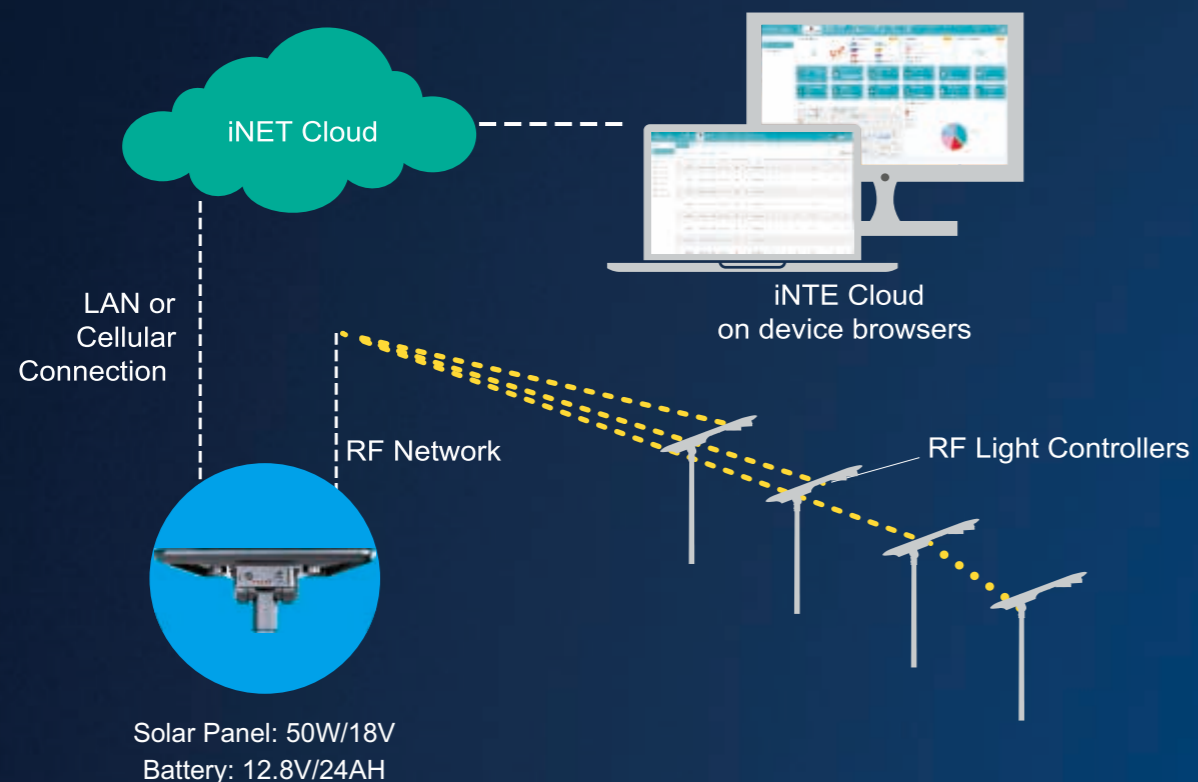

- The solar street light management system can pre-set one or more lighting modes according to the different time of day and traffic flow, automatically turn on or off any light, and adjust the switching time and illumination according to environmental requirements to achieve the purpose of energy-saving and consumption reducing.

- The integrated system is mainly composed of a street light component a centralized controller, a single light controller, and a smart cloud platform. The centralized controller and the single light controller aggregate the data collected by the single light via the RF wireless communication network. The centralized controller uploads data to the system cloud platform through GPRS data flow, providing data dependence for mobile phone and computer terminal access.



## System & Hardwares



- 
**Automatic Light On/Off & Dimming Control**
  - By time setting
  - On/off or dimming with motion sensor detection
  - On/off or dimming with photocell detection
- 
**Accurate Operation & Fault Monitor**
  - Real-time monitor on each light working status
  - Accurate report on fault detected
  - Provide location of fault, no patrol required
  - Collect each light operation data, such as voltage, current, power consumption
- 
**Extra I/O Ports for Sensor Expandability**
  - Environment Monitor
  - Traffic Monitor
  - Security Surveillance
  - Seismic Activities Monitor
- 
**Reliable Mesh Network**
  - Self proprietary wireless control node
  - Reliable node to node, gateway to node communication
  - Up to 1000 nodes per network
  - Max. network diameter 2000m
- 
**Easy-to-use Platform**
  - Easy monitor on each and all lights status
  - Support lighting policy remote set-up
  - Cloud server accessible from computer or hand held device



# ORDERING INFORMATION

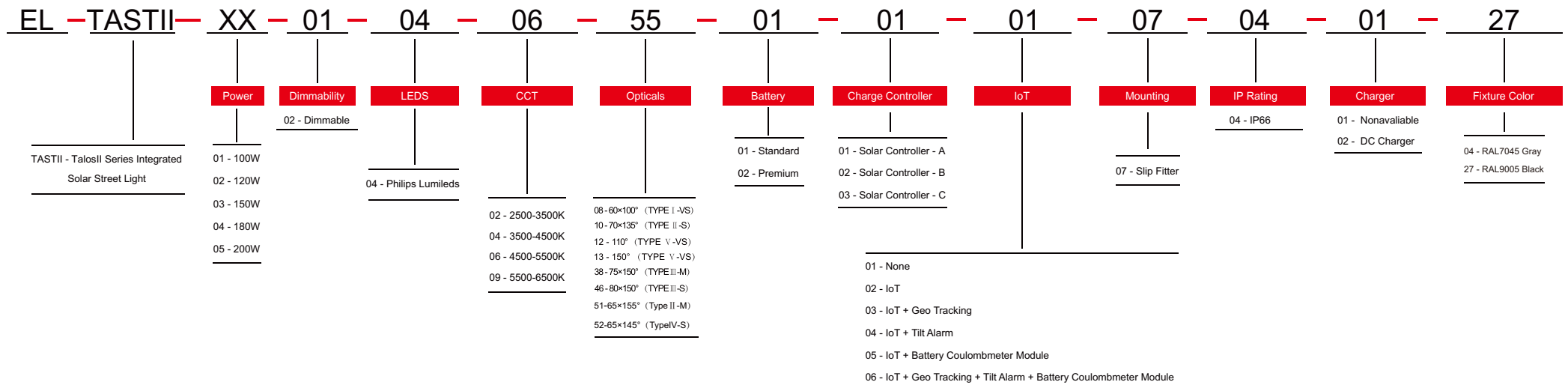

E-Lite Semiconductor Co., Ltd.  
 Headquarter & Factory  
 Website: <http://www.elitesemicon.com>